

TANGO



Fase¹

BRAVO
OSCAR
TANGO



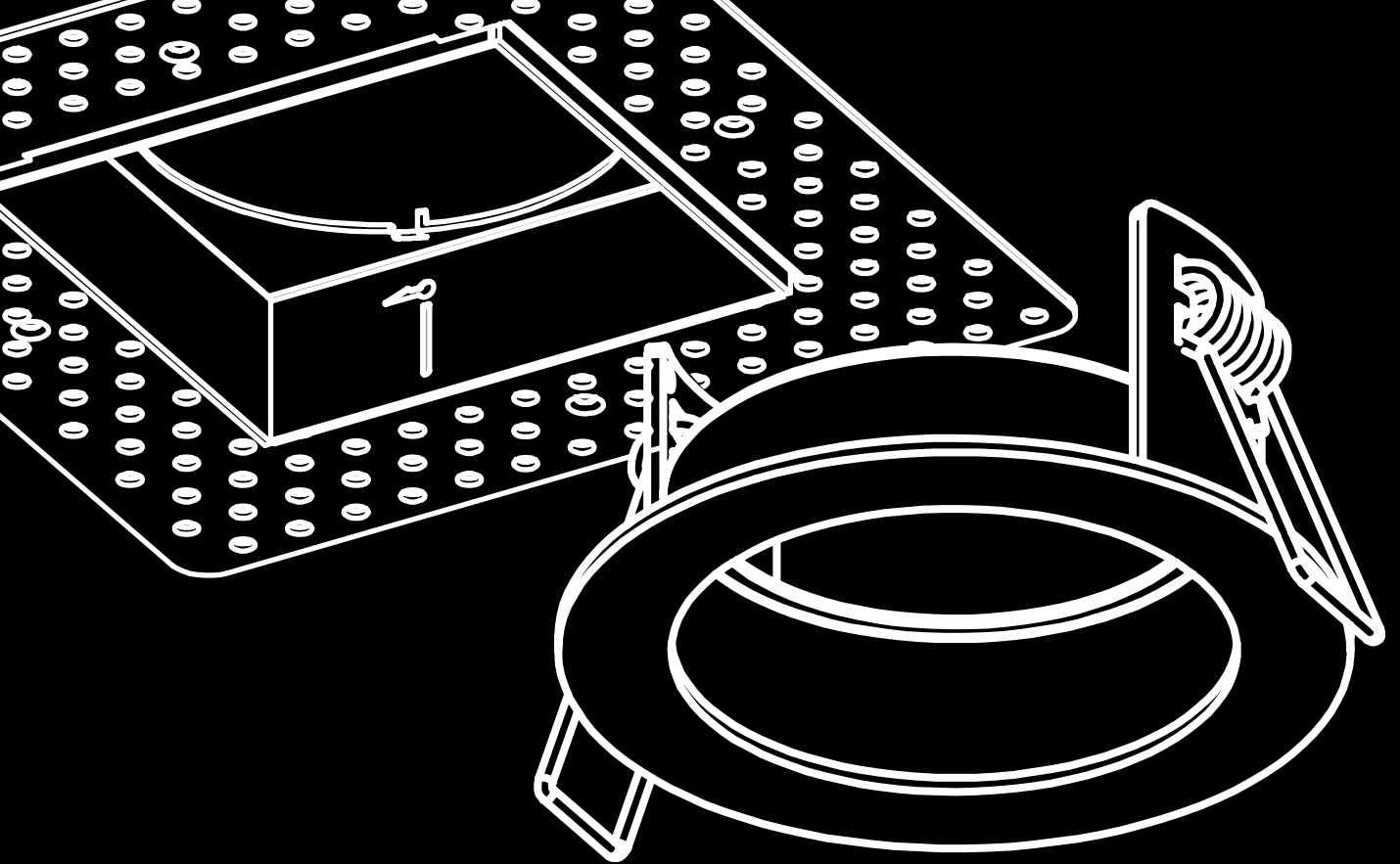

Introducing

THE TANGO

Tango is a specification grade LED collection, offering multiple options for design and functionality. It offers round and square, trim and trimless, 1-, 2-, and 3-light options, along with several task specific trim designs. Tango features 90+ CRI high performance LED chips, drivers with multi dimming capabilities, and supports industry leading ease of installation and services.

The sleek and contemporary design of the Tango collection will illuminate your space with precision and style. Let's tango.

TANGO

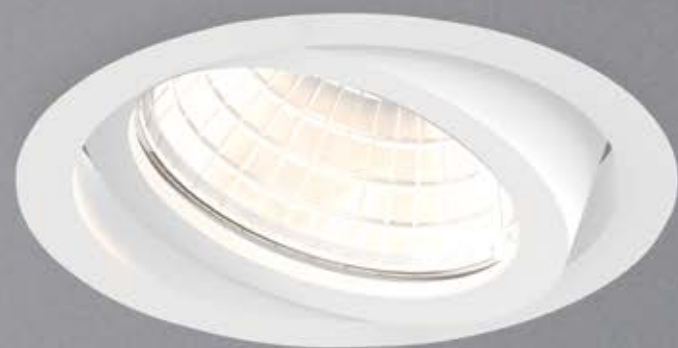
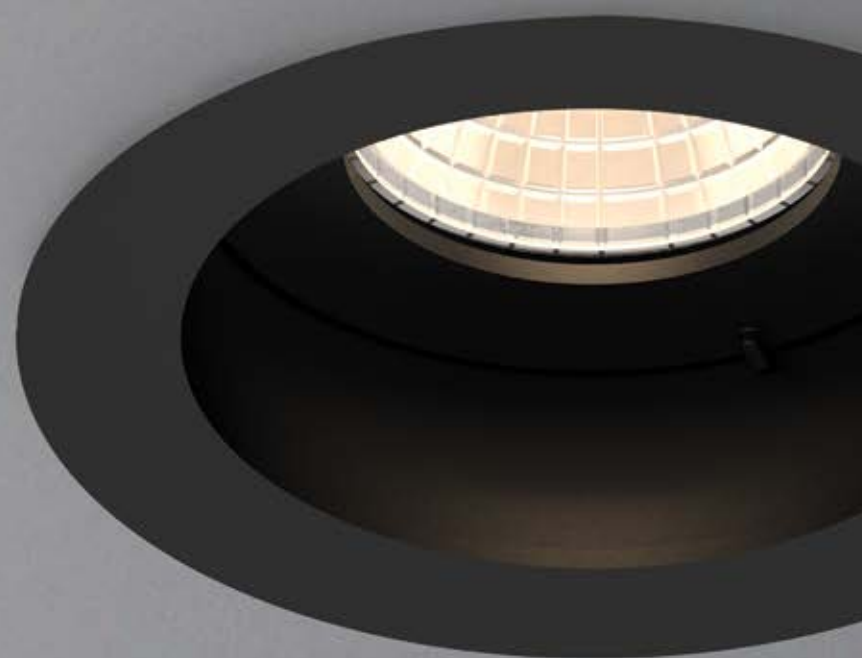

LIGHT CHOICE

Each Tango module sports an aluminum body with powder coated finish and aluminum die cast trim that makes this versatile collection extremely durable. Its housing design with proprietary hidden heat sink mechanism protects LED life for longevity as it increases the heat flow away by absorbing thermal energy and then dispersing it into the surrounding ambient air.



FIELD ADAPTATIONS



FIXED

As its name implies, this is an immovable light. Directed downward, the angle and size is based on the angle of the beam within its globe. Super easy to install, this option provides even illumination and makes this the common favorite for general lighting.



All housing available in white, black, round, square, trim, trimless, and multiples options

LAMPING

| | | |
|-------------|-----------------------------|-----------------------------|
| Wattage: | 10W | 15W |
| Source: | Integrated LED | Integrated LED |
| Beam angle: | 15°/24°/38° | 15°/24°/38° |
| Kelvin: | 2700K/3000K/3500K/4000K | 2700K/3000K/3500K/4000K |
| Lumens: | 840lm | 1180lm |
| CRI: | 90+ | 90+ |
| Dimming: | 0-10V/ELV/Triac | 0-10V/ELV/Triac |
| Location: | Damp | Damp |
| Input: | 120-277V (347 upon request) | 120-277V (347 upon request) |
| Color: | Black/White | Black/White |
| Type: | Round/Square | Round/Square |
| | Trim/Trimless | Trim/Trimless |
| | 1-light/2-light/3-light | 1-light/2-light/3-light |

SPECIFICATION DRAWINGS

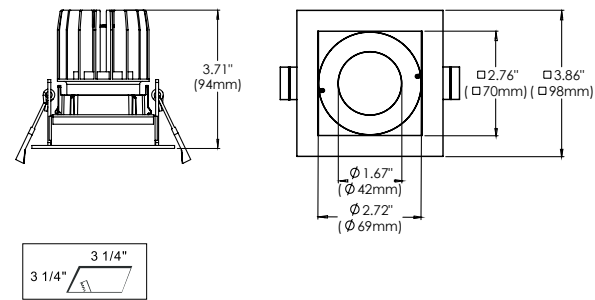

EXAMPLE

Ceiling cut-outs will vary depending on housing. Please refer to each specifications. Example shown is for a square 1-light with trim.

10W WIDE

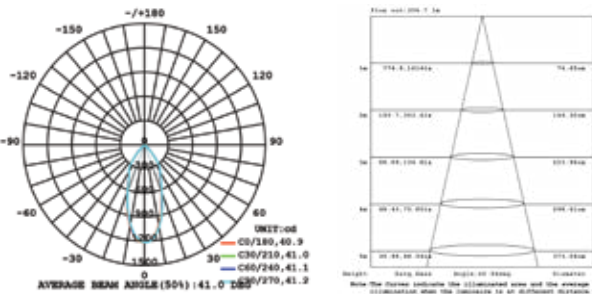

15W WIDE

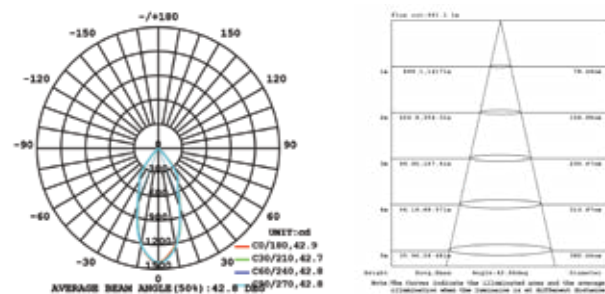

** See pg 28 for full photometrics

*** For customization, please consult Eurofase

GIMBAL

A pivoting support within the housing to limit the lamp from extending outside the ceiling. Rotating the lens around its center of gravity, you can direct light wherever needed to allow a range of directional lighting. The flexibility of its adjustable downlights make this an ideal choice for task and accent lighting.

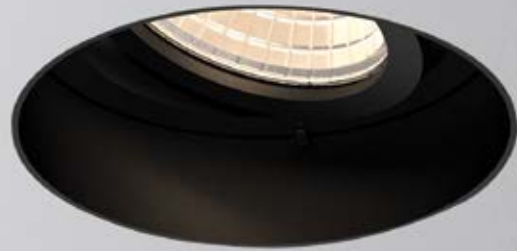

All housing available in white, black, round, square, trim, trimless, and multiples options

LAMPING

| | | |
|-------------|-----------------------------|-----------------------------|
| Wattage: | 10W | 15W |
| Source: | Integrated LED | Integrated LED |
| Beam angle: | 15°/24°/38° | 15°/24°/38° |
| Kelvin: | 2700K/3000K/3500K/4000K | 2700K/3000K/3500K/4000K |
| Lumens: | 840lm | 1180lm |
| CRI: | 90+ | 90+ |
| Dimming: | 0-10V/ELV/Triac | 0-10V/ELV/Triac |
| Location: | Damp | Damp |
| Input: | 120-277V (347 upon request) | 120-277V (347 upon request) |
| Color: | Black/White | Black/White |
| Type: | Round/Square | Round/Square |
| | Trim/Trimless | Trim/Trimless |
| | 1-light/2-light/3-light | 1-light/2-light/3-light |

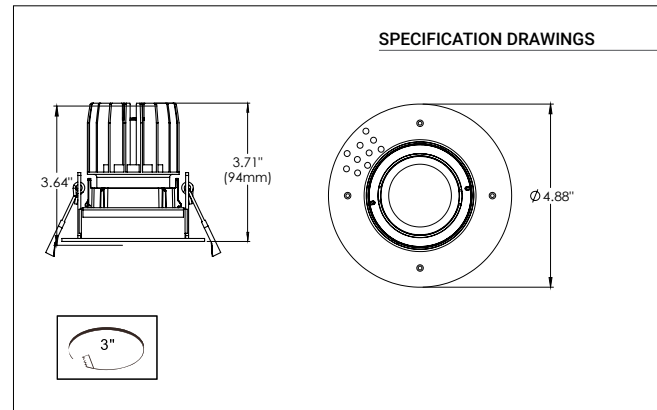

EXAMPLE

Ceiling cut-outs will vary depending on housing. Please refer to each specifications. Example shown is for a round 1-light without trim.

10W WIDE

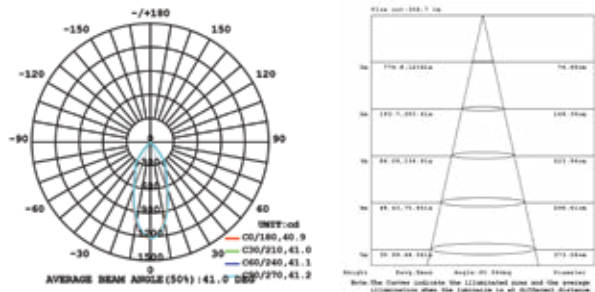

15W WIDE

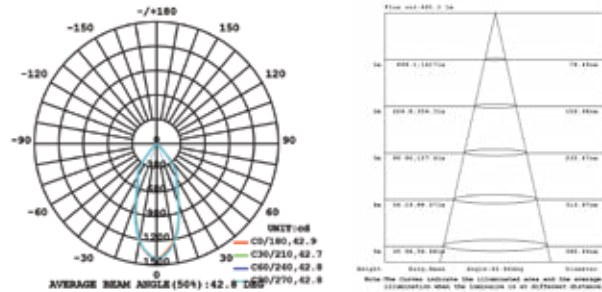

** See pg 28 for full photometrics
 *** For customization, please consult Eurofase

SPOT*

The spot module is the best choice for directional lighting to highlight specific pieces that deserve that extra attention. For hanging art, sculptures, and even a little reading nook, you can shape the perfect ambiance by adding supplementary layered lighting.

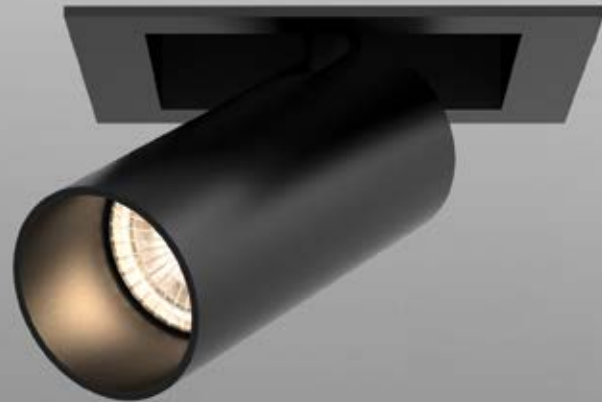

*Module includes lens and reflector inside for complete base



All housing available in white, black, round, square, trim, trimless, and multiples options

LAMPING

Wattage: 15W
 Source: Integrated LED
 Beam angle: 15°/24°/38°
 Kelvin: 2700K/3000K/3500K/4000K
 Lumens: 1060lm
 CRI: 90+
 Dimming: 0-10V/ELV/Triac
 Location: Damp
 Input: 120-277V (347 upon request)
 Color: Black/White
 Type: Round/Square
 Trim/Trimless
 1-light/2-light/3-light

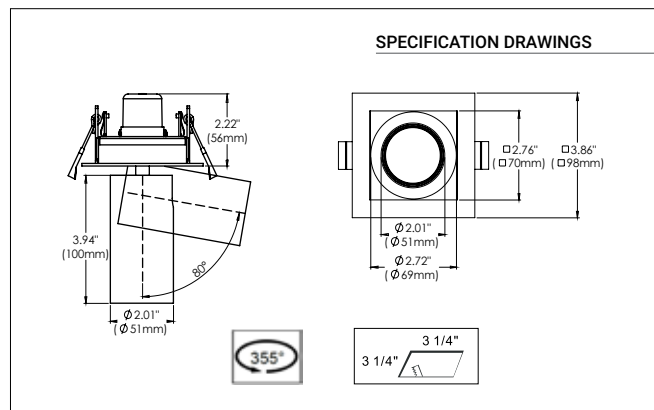

EXAMPLE

Ceiling cut-outs will vary depending on housing.
 Please refer to each specifications. Example shown is for a 1-light square with trim.

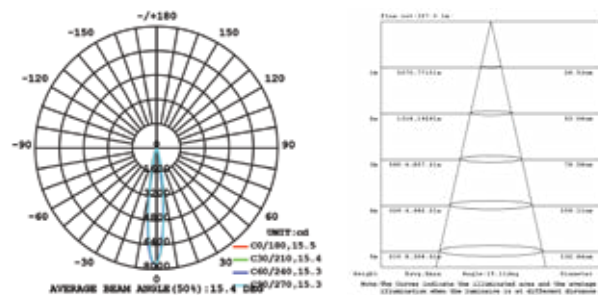

** See pg 29 for full photometrics
 *** For customization, please consult Eurofase



SUSPENSION*

This hanging module comes ready-to-install onto the plate. It includes the lens and reflector assembled within.

As the more decorative piece of this collection, the suspension module works just like a hanging pendant but has a sleeker and more compact design. It's small canopy sits flush against the ceiling and is available in a trimless option for a seamless look.



*Module includes lens and reflector inside for complete base



All housing available in white, black, round, square, trim, trimless, and multiples options

LAMPING

Wattage: 15W
 Source: Integrated LED
 Beam angle: 15°/24°/38°
 Kelvin: 2700K/3000K/3500K/4000K
 Lumens: 1060lm
 CRI: 90+
 Dimming: 0-10V/ELV/Triac
 Location: Damp
 Input: 120-277V (347 upon request)
 Color: Black/White
 Type: Round/Square
 Trim/Trimless
 1-light/2-light/3-light

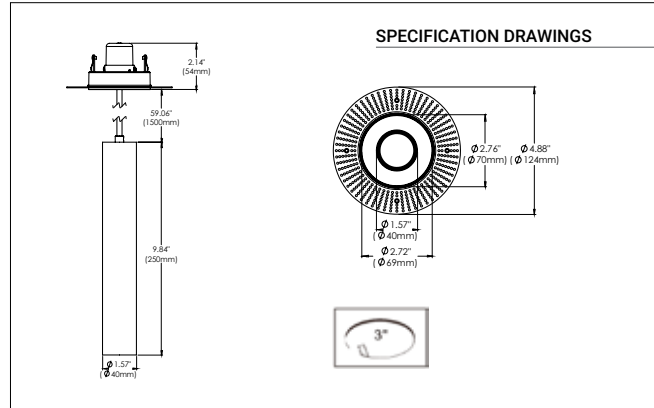

EXAMPLE

Ceiling cut-outs will vary depending on housing. Please refer to each specifications. Example shown is for a 1-light round without trim.

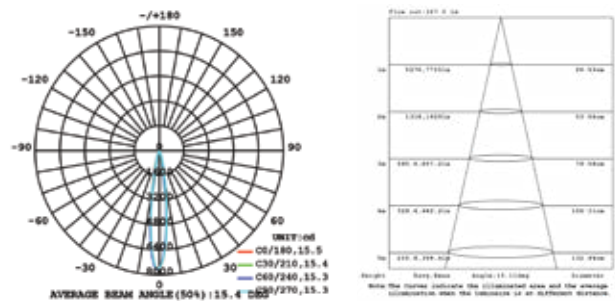

** See pg 29 for full photometrics
 *** For customization, please consult Eurofase

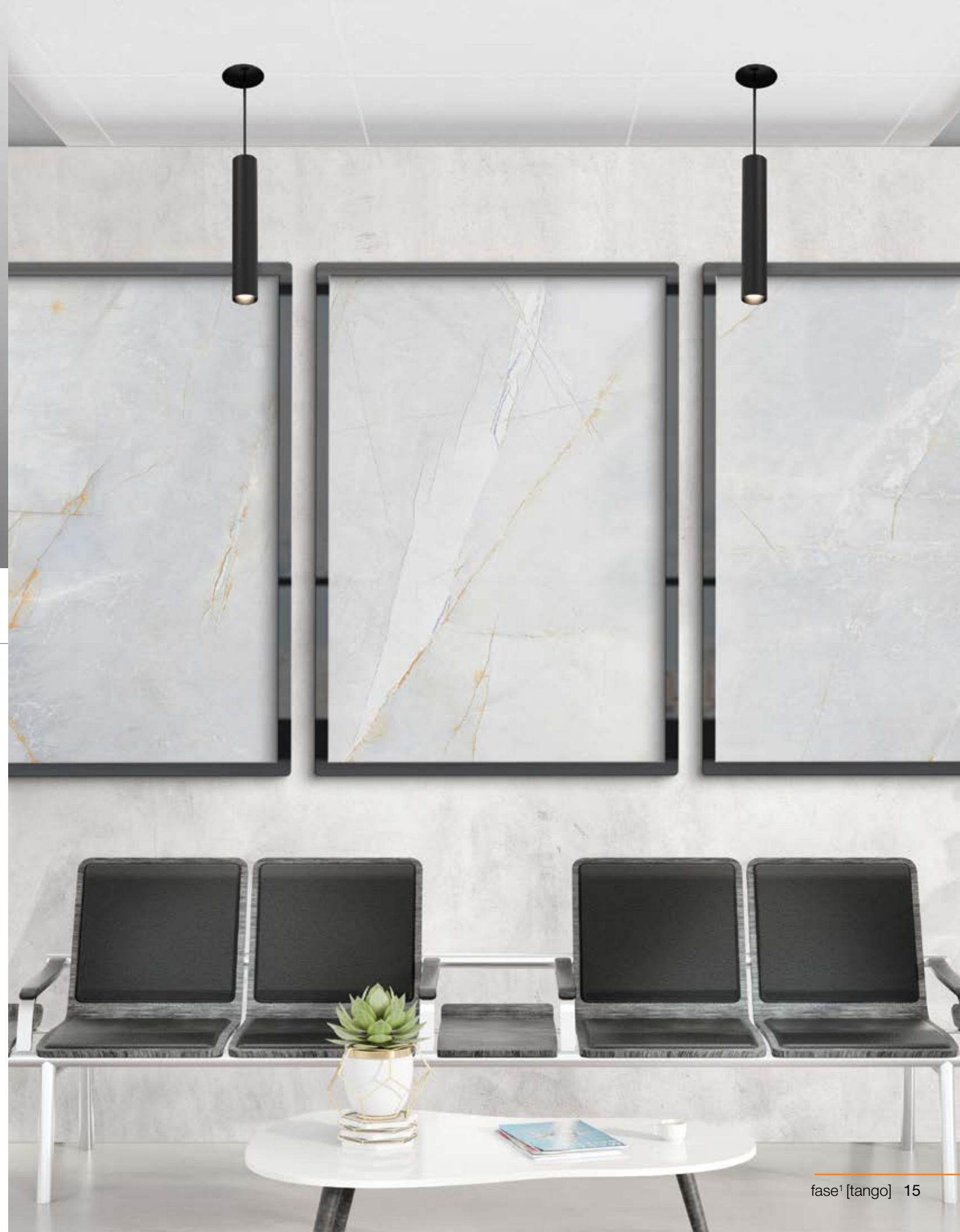

PULL DOWN*



This extremely versatile option offers spot lighting that can adapt to the changes of your decor. Through time, it's expected for interiors to change and shift its purpose. With the Pull Down module, you can still provide directional lighting to highlight specific items while keeping your current light system intact.

For galleries and retail spaces, especially, where they are constantly undergoing changes, the Pull Down module can provide specific spot lighting and then convert into a recessed option afterwards for general illumination.

*Module includes lens and reflector inside for complete base



All housing available in white, black, round, square, trim, trimless, and multiples options

LAMPING

Wattage: 15W
 Source: Integrated LED
 Beam angle: 15°/24°/38°
 Kelvin: 2700K/3000K/3500K/4000K
 Lumens: 1060lm
 CRI: 90+
 Dimming: 0-10V/ELV/Triac
 Location: Damp
 Input: 120-277V (347 upon request)
 Color: Black/White
 Type: Round/Square
 Trim/Trimless
 1-light/2-light/3-light

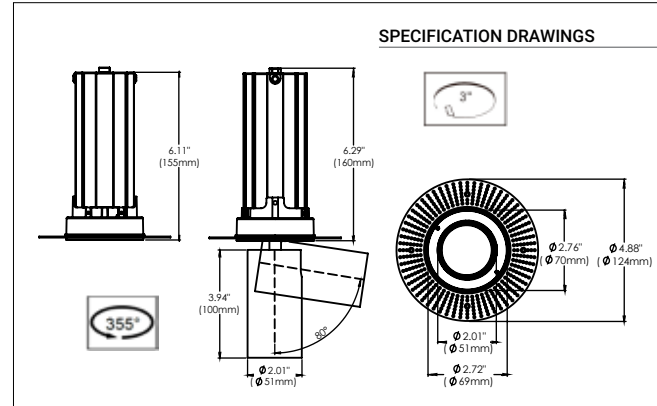

EXAMPLE

Ceiling cut-outs will vary depending on housing. Please refer to each specifications. Example shown is for a 1-light round without trim.

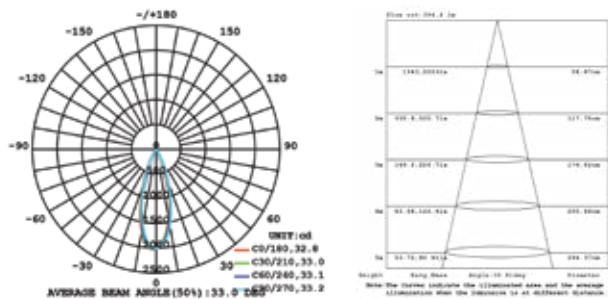

** See pg 29 for full photometrics
 *** For customization, please consult Eurofase





01

ACCESSORIES

OPTIC REFLECTORS: Beam Angle

| | |
|------------|------------|
| Spot | Narrow 15° |
| Flood | Medium 24° |
| Wide Flood | Wide 38° |



Reflectors installed into the light engine, before the diffusers

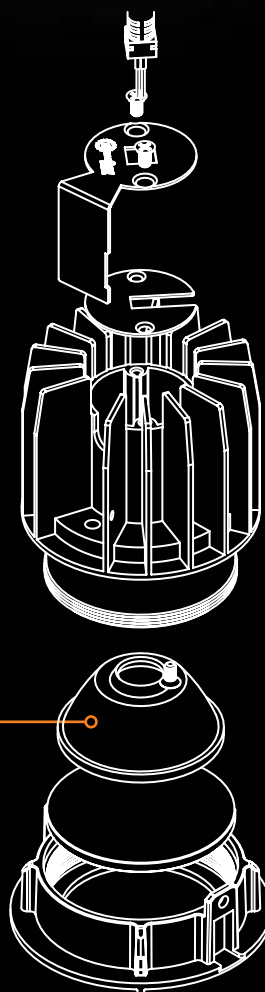

02

LENS: Diffuser

Standard Lens (INCLUDED)
Clear glass protective lens

Dichroic Lens
Accurately filter colors to change room ambiance (Orange/Red/Blue/Green)

Spread Lens
Wider beam diffuser to focus on larger objects

Linear Spread Lens
Oval flood beam best suited for wall washing applications

Frosted Lens
Disperses light evenly with a soft, diffused glow



03

ADD-ONS: Extensions

Extension Baffle
This extension baffle focuses the light beam, which reduces light spill and improves lighting efficiency. Adding the extension baffle along with your choice of reflector greatly improves the illumination your downlight produces.

Extension Snoot
Adding an extension tube further supports the ability to control the direction and radius of a light beam. Acting similarly to the extension baffle, the snoot add-on is more for aesthetic purposes. A modern cylinder tube will add a decorative purpose while creating a focused beam of light.

Honeycomb Louvre
This slim filter has lighting comfort properties for optimal illumination. The honeycomb louvre reduces glare, distortion and provides better clarity.

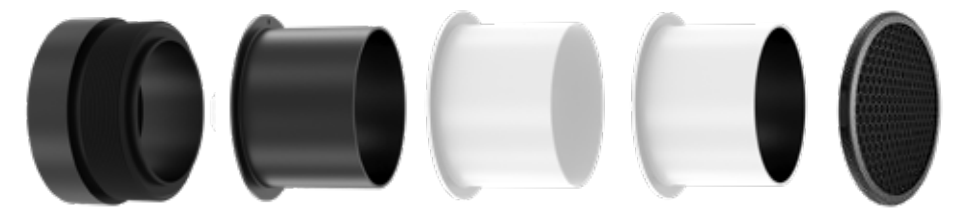

Snoot
(Black ext/int)
(SN1)

Snoot
(White ext/int)
(SN2)

Snoot
(White ext/Black int)
(SN3)

LASTING IMPRESSION

The Tango collection are UL Listed to ensure safe operation for many years to come. We want to ensure your success with every project you tackle. We're also offering a 5 year limited warranty.



HOUSINGS

FIXED

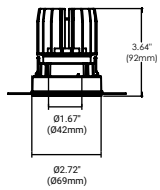

GIMBAL

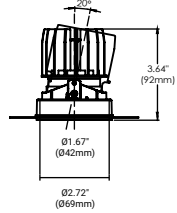

SPOT

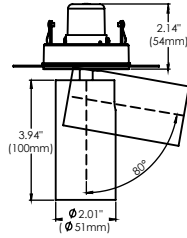

SUSPENSION

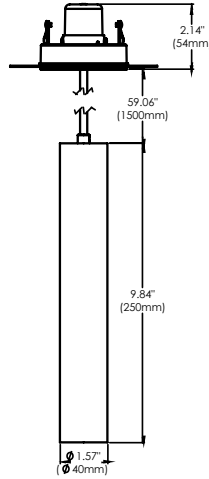

PULL DOWN

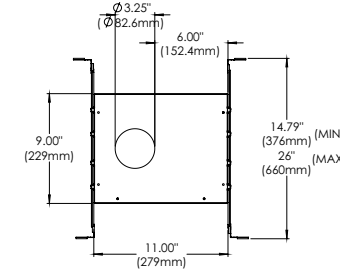
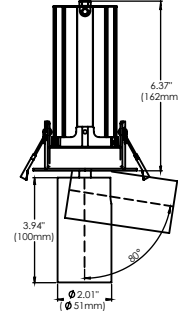

NCP and IC/AT
1-Light Round

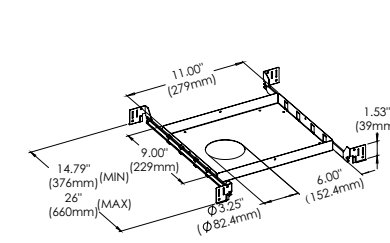

NCP 1-Light Round
41943-014

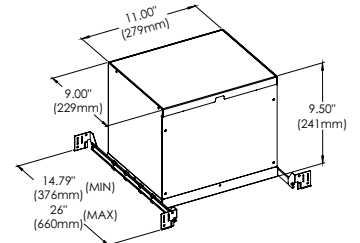

IC 1-Light Round
41944-011
AT 1-Light Round
41945-018

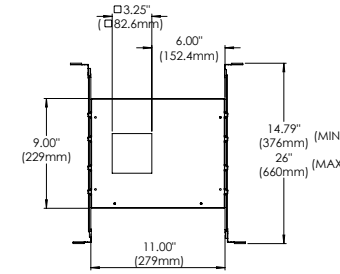

NCP and IC/AT
1-Light Square

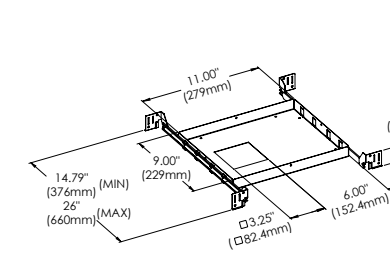

NCP 1-Light Square
41946-015

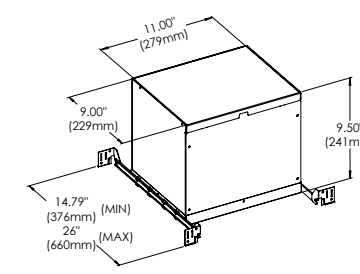

IC 1-Light Square
41947-012
AT 1-Light Square
41948-019

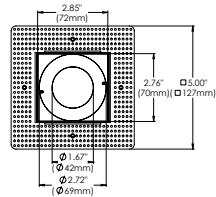

1 Light Square Trimless - Bottom View

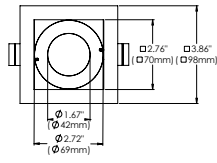

1 Light Square Trim - Bottom View

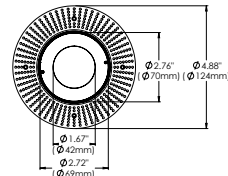

1 Light Round Trimless - Bottom View

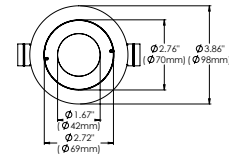

1 Light Round Trim - Bottom View

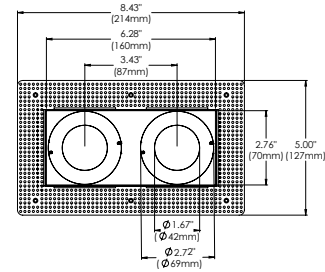

2 Light Square Trimless - Bottom View

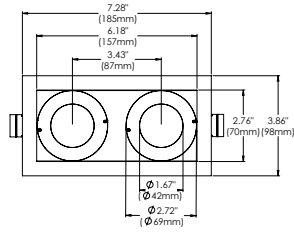

2 Light Square Trim - Bottom View

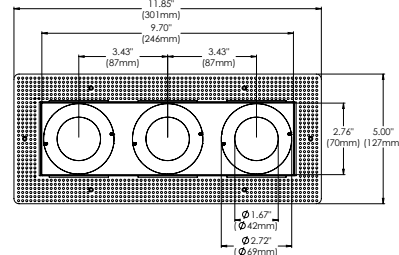

2 Light Square Trimless - Bottom View

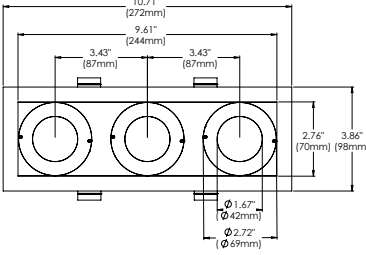

2 Light Square Trim - Bottom View

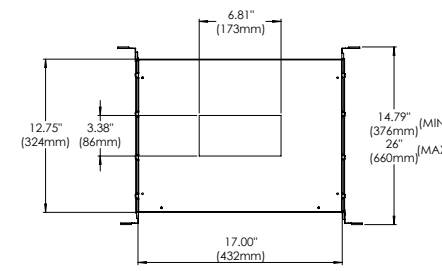

NCP and IC/AT
2-Light Rectangular

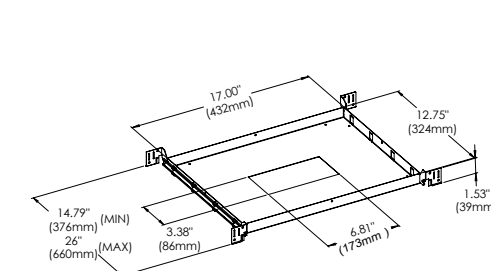

NCP 2-Light Rectangular
41949-016

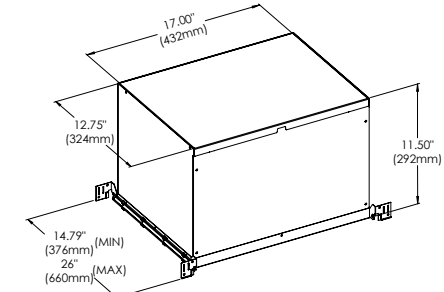

IC 2-Light Rectangular
41950-012
AT 2-Light Rectangular
41951-019

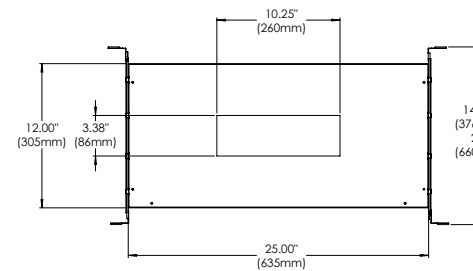

NCP and IC/AT
3-Light Rectangular

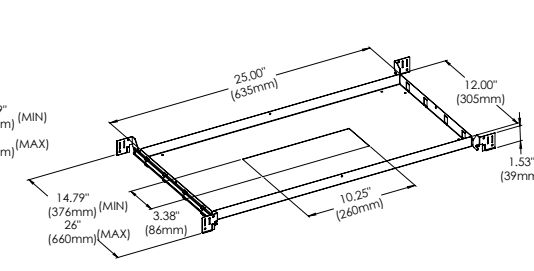

NCP 3-Light Rectangular
41952-016 (trim)
43668-014 (trimless)

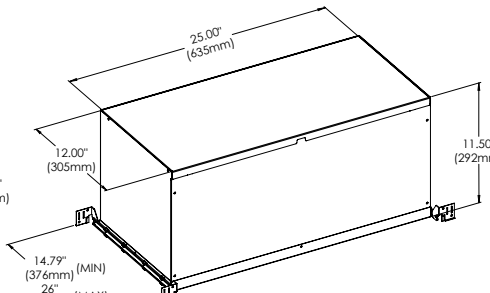

IC 3-Light Rectangular
41953-013 (trim)
43669-011 (trimless)
AT 3-Light Rectangular
41954-010 (trim)
43670-017 (trimless)

ELECTRICAL

- Class 2 dimmable constant current driver (included)
- Driver box mates to fixture by 12" flexible BX cable
- Thermally protected
- Input voltage: 120V. For 277V and 347V input options consult Fase1 Lighting.

HOUSING

- 18 gauge powder coated steel housing
- Remodel housing complete with adjustable mounting clips suitable for 1/2" and 5/8" drywall
- New construction plate, insulated ceiling box and airtight IC box sold separately (refer to housing options)

INSTALLATION GUIDE

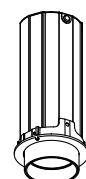
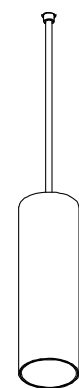
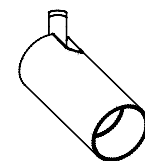
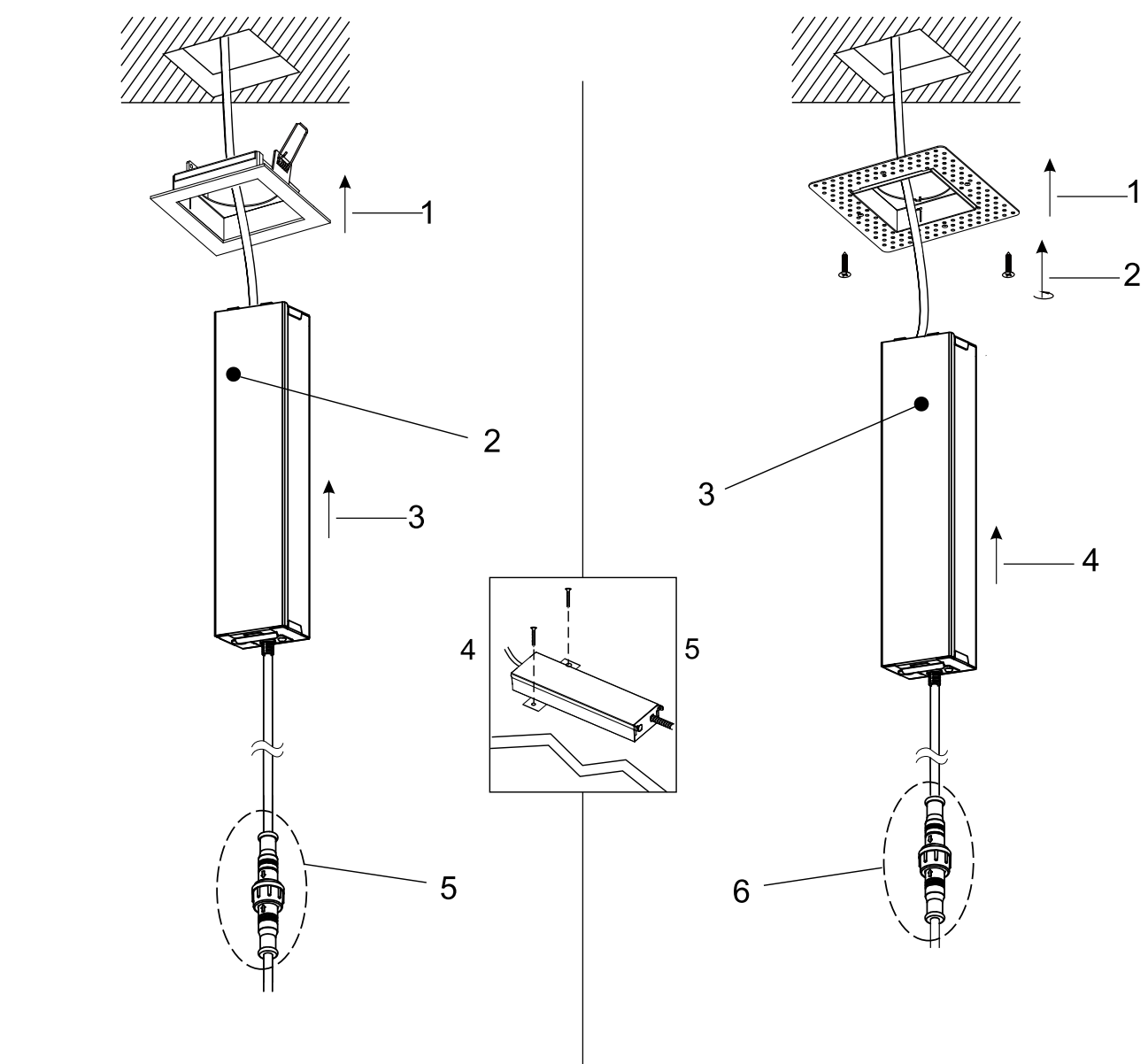

PHOTOMETRICS

A photometric analysis illustrates how light emanates from certain fixtures onto the space surrounding it. With this information, you will be able to determine which modules are necessary or required for the intended purpose.

FIXED



10W 1-LIGHT FIXED NARROW CLEAR

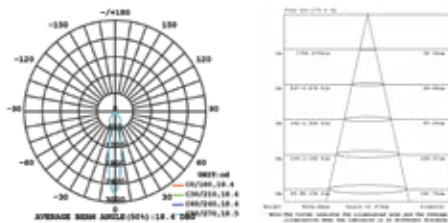

10W 1-LIGHT FIXED MEDIUM CLEAR

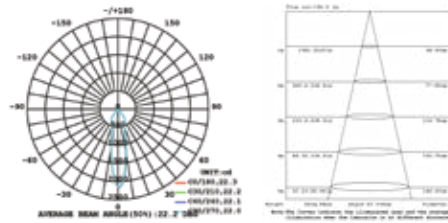

10W 1-LIGHT FIXED WIDE CLEAR

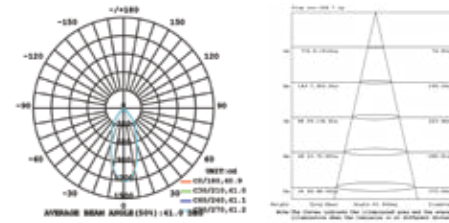

15W 1-LIGHT FIXED NARROW CLEAR

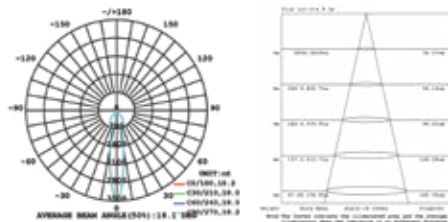

15W 1-LIGHT FIXED MEDIUM CLEAR

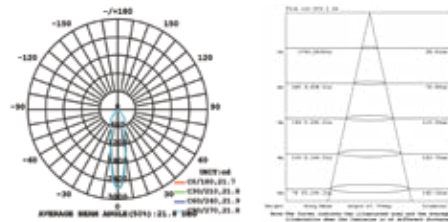

15W 1-LIGHT FIXED WIDE CLEAR

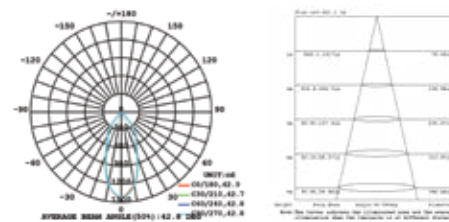

SPOT

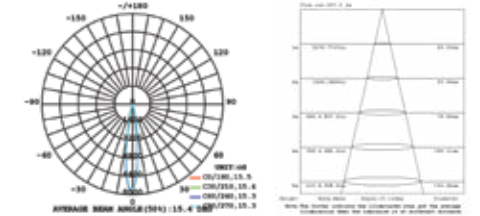

SUSPENSION

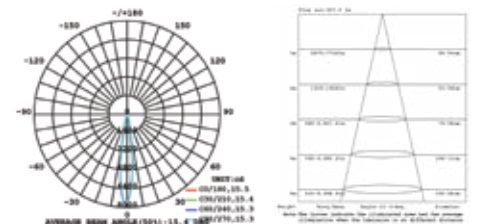

GIMBAL



10W 1-LIGHT GIMBAL NARROW CLEAR

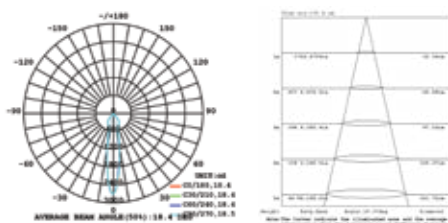

10W 1-LIGHT GIMBAL MEDIUM CLEAR

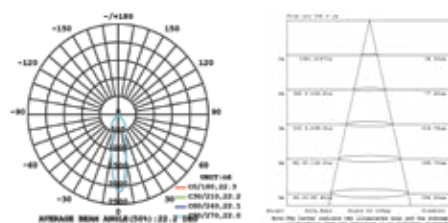

10W 1-LIGHT GIMBAL WIDE CLEAR

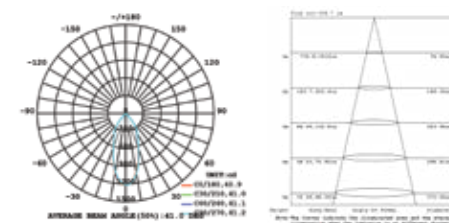

15W 1-LIGHT GIMBAL NARROW CLEAR

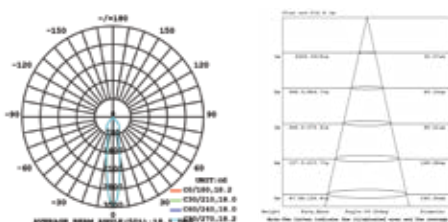

15W 1-LIGHT GIMBAL MEDIUM CLEAR

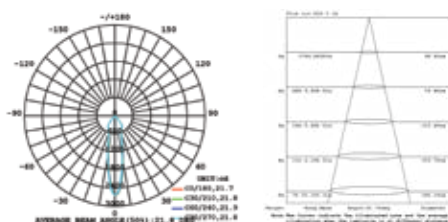

15W 1-LIGHT GIMBAL WIDE CLEAR

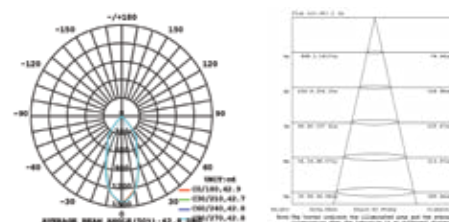

PULL DOWN

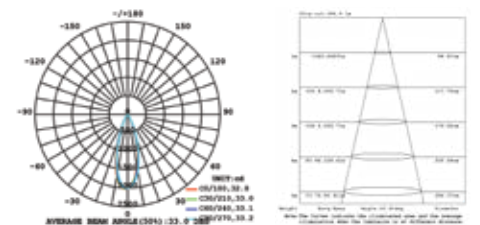



EASY AS 123

Adding or removing accessories can easily be done in 3 simple steps.

Field Adjustable

With an extensive list of customized options, it is our goal to make the application exceptionally uncomplicated. Each light engine is equipped with quick connect attachments for ease of installation. This allows individual modules to be interchanged well after the installation is made. When recessed lighting is already installed, it is harder to maneuver around the product to make even the simplest of changes but this mitigates all that. This handy feature is especially beneficial in the event a module burns out.

Quick Connect

Simply twist the latch to reveal the connector beneath and then separate the cables in 2 easy steps.

IC-Rated Engine

An IC-rated light engine at 10W is now available for even more applications along with 2 CCT light engines to cover a range from 2700K to 4000K.

High Performance LED Chip + Driver

Employs an ESS Series LED Driver with Tri-Mode Dimming and worldwide safety approvals.

UPGRADES THAT SHINE





FULL CONTROL

Start at the very beginning by figuring out how many lights you would like. Choose from a 1-, 2-, or 3-light base then move onto your preferred shape. Options include a round or square form in black or white. From there, you can also decide whether or not to include a trim or leave it trimless for a seamless look and feel.

ORDERING GUIDE

Start at the very beginning by figuring out how many lights you would like. Choose from a 1-, 2-, or 3-light base then move onto your preferred shape. Options include a round or square form with or without trim. From there, you can decide to use either black or white to match your decor.

1 This first step involves 4 easy parts.

Choose:
No. of lights | Shape | Trim or Trimless | Color



2 Decide the type of lighting required



3 Design your configuration

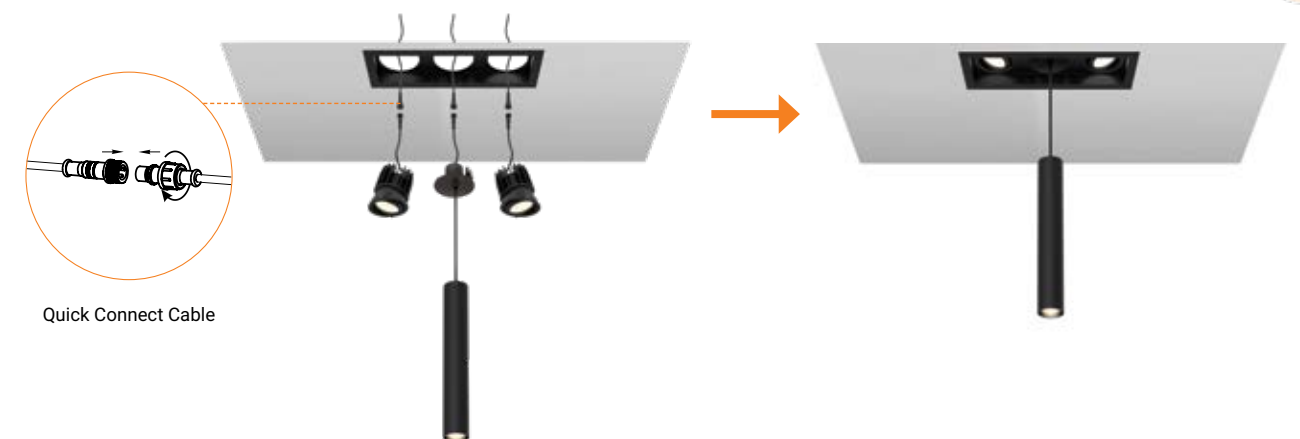

CONFIGURATOR

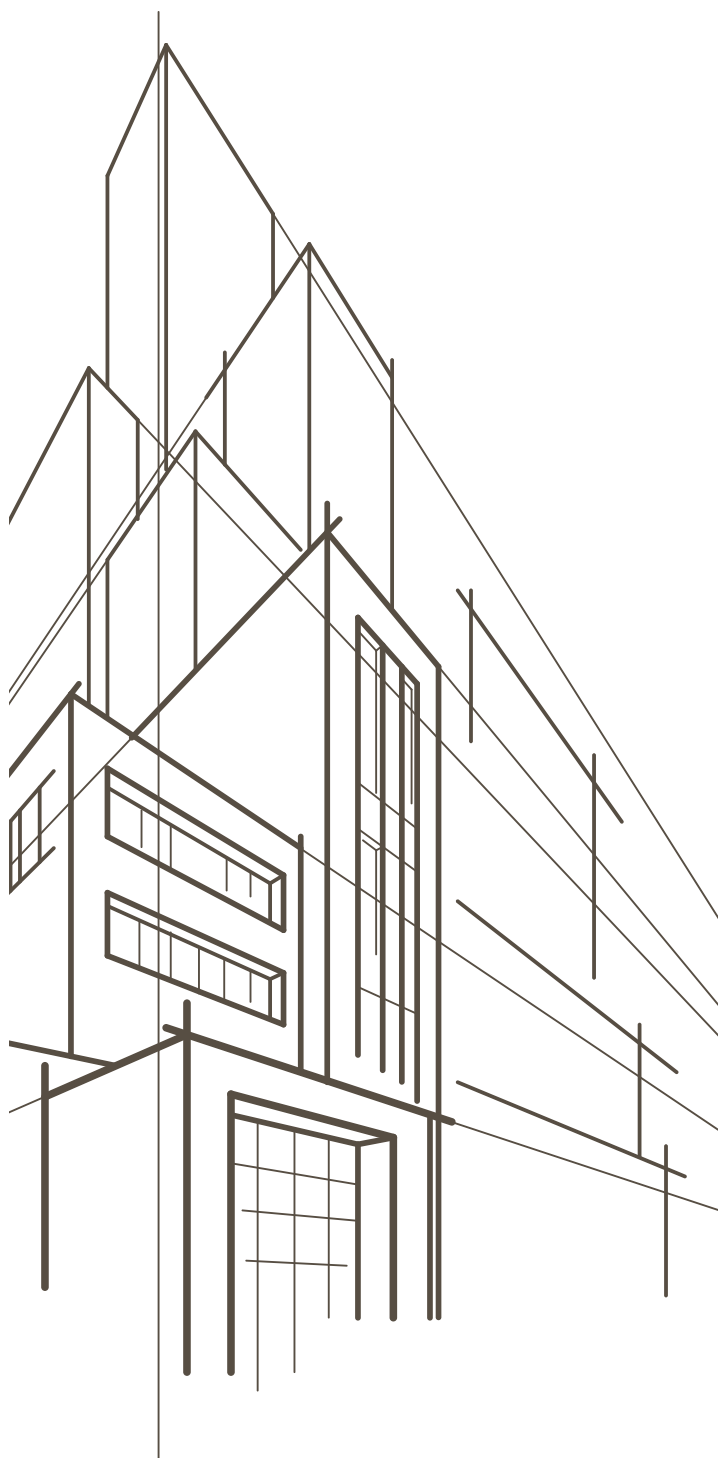

BEGIN BUILDING YOUR 1-LIGHT CONFIGURATION

PART A

If you are designing for a 1-light configuration, continue onto PART C.

| COLLECTION (FAMILY NAME) | NO. OF LIGHTS | | TRIM | | COLOR | | MODULE 01 | |
|--------------------------|---------------|----------------|------|----------|-------|-------|-----------|-----------------|
| TGO | 1R | 1 LIGHT ROUND | T | TRIMMED | 01 | BLACK | RG | RECESSED GIMBAL |
| | 1S | 1 LIGHT SQUARE | TL | TRIMLESS | 02 | WHITE | RF | RECESSED FIXED |
| | 2 | 2 LIGHT | | | | | SU | SUSPENSION |
| | 3 | 3 LIGHT | | | | | ST | SPOT |
| | | | | | | | PD | PULL DOWN |

CONTINUE CHOOSING YOUR MODULES FOR 2-LIGHT AND 3-LIGHT HOUSINGS

PART B

If you are designing for a 2-light or 3-light configuration, continue to choose your modules accordingly..

| MODULE 02 | | MODULE 03 | |
|-----------|-----------------|-----------|-----------------|
| RG | RECESSED GIMBAL | RG | RECESSED GIMBAL |
| RF | RECESSED FIXED | RF | RECESSED FIXED |
| SU | SUSPENSION | SU | SUSPENSION |
| ST | SPOT | ST | SPOT |
| PD | PULL DOWN | PD | PULL DOWN |

COMPLETE YOUR ORDER BY CHOOSING YOUR SPECIFICS

PART C

Finish your order by choosing the wattage, color temperature, beam angle, and the diffuser accessory.

| WATT | | CCT | | BEAM ANGLE | | DIFFUSER | | ADD-ONS | |
|------|------------|-----|-------|------------|------------|----------|------------------------|---------|-------------------------------|
| 10 | 10W IC | 27 | 2700K | N | 15° NARROW | CL | CLEAR DIFFUSER | XT | EXTENSION BAFFLE |
| 15 | 15W NON-IC | 30 | 3000K | M | 24° MEDIUM | LN | LINEAR SPREAD DIFFUSER | SN1 | SNOOT (BLACK EXT + INT) |
| | | 35 | 3500K | W | 38° WIDE | FR | FROSTED DIFFUSER | SN2 | SNOOT (WHITE EXT + INT) |
| | | 40 | 4000K | | | SP | SPREAD DIFFUSER | SN3 | SNOOT (WHITE EXT + BLACK INT) |
| | | | | | | RE | RED DICHROIC | HC | HONEYCOMB LOUVRE |
| | | | | | | GR | GREEN DICHROIC | | |
| | | | | | | BL | BLUE DICHROIC | | |
| | | | | | | OR | ORANGE DICHROIC | | |

Fase¹

33 West Beaver Creek Road,
Richmond Hill, Ontario Canada L4B 1L8

DALLAS TRADE MART
Eurofase Showroom, Suite #4002

tel 905.695.2055
fax 905.695.2056

toll free 1.800.660.5391
toll free 1.800.660.5390



Printed in Canada
© 2021 Eurofase Inc. All rights reserved.

Eurofase Inc. reserves the right to make alterations to the construction and design of products shown in this catalog in order to meet the laws or regulations of any authorized governing organization. The use of products shown in this catalog must comply with local building codes.